

# Norse



**terratinta** 100%  
ceramiche made in  
Italy



## Index

---

Norse	p. 04
Collection	p. 06
Decorative Program	p. 36
Norse Outdoor	p. 44
Packaging	p. 50
Technical features	p. 52

---

# Norse

<sup>EN</sup>It is the story of a material which, thanks to its qualities of neutrality and versatility of use, becomes the protagonist of ceramic projects capable of experimenting with new design and aesthetic standards. Norse comes in various sizes developed in a palette of 7 neutral shades, both warm and cold, characterized by a surface that presents the effect of manual drafting with a slight graphic movement and is completed with new decorative patterns perfectly matched to create refined and unusual total looks and guarantee a high level of customization in line with current trends for increasingly original and individual settings, casual and comfortable but at the same time with elegant sobriety and which promote the idea of "intimacy" as a lifestyle, a perfect marriage of neat minimalism that is also warm and inviting.

<sup>IT</sup>E' il racconto di un materiale che, grazie alle sue qualità di neutralità e versatilità di impiego diviene protagonista di progetti ceramici capaci di sperimentare nuovi canoni progettuali ed estetici. Norse si sviluppa in diversi formati declinati in una palette di 7 tonalità neutre, sia calde che fredde, caratterizzate da una superficie che presenta un effetto di stesura manuale con un leggero movimento grafico e si completa con patterns decorativi inediti perfettamente abbinati per creare total look ricercati e inusuali e garantire un elevato livello di personalizzazione in linea con le tendenze attuali per ambienti sempre più originali e individuali, casual e confortevoli ma al tempo stesso dalla sobrietà elegante e che promuovano l'idea di "intimità" come stile di vita, un perfetto connubio tra un minimalismo ordinato che è anche caldo e invitante.



# Norse

Material: Porcelain stoneware | Gres porcellanato

Surface: matt RIO and ultra matt R11 rectified | matt RIO e ultra matt R11 rettificato

Thickness: matt 10mm | ultra matt 20mm **TH/CK**<sub>20mm</sub>

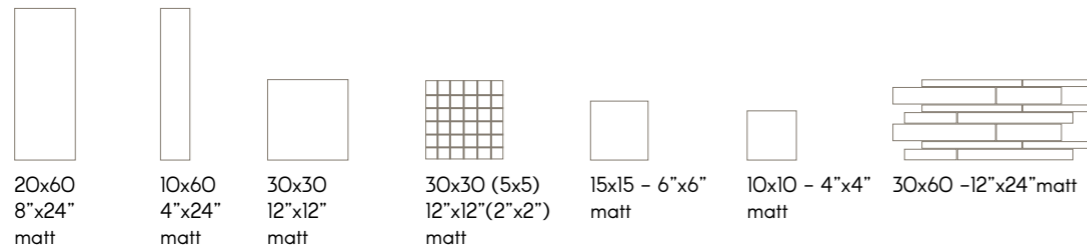
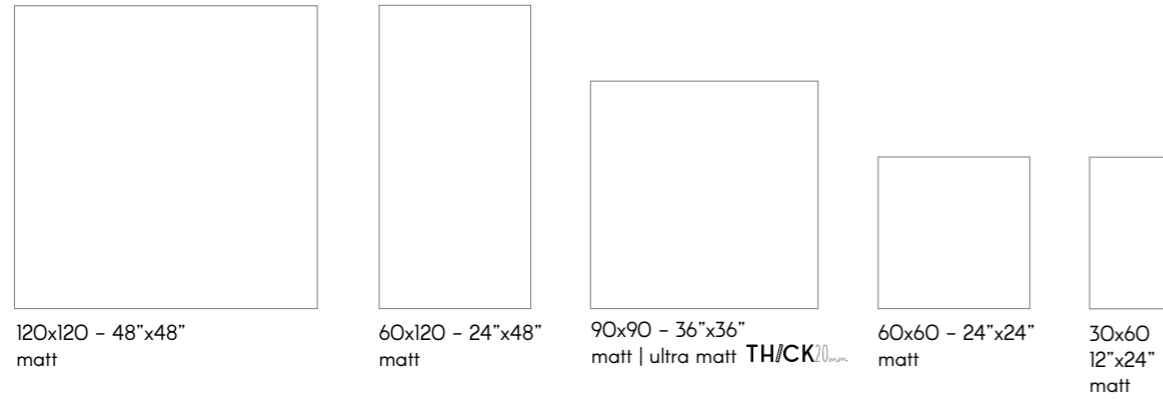

Fog

Powder

Clay

Ash

Mud

Crete

Earth

# Fog



Fog 60x120 - 24"x48"



Wall: Fog 60x120 - 24"x48"  
Floor: Fog 60x60 - 24"x24"

Fog



# Powder



Powder 90x90 - 36"x36"

Floor: Powder 90x90 - 36"x36"



Powder





# Clay



Wall: Clay 60x120 - 24"x48"  
Roller Clay 10x30 - 4"x12"  
Floor: Clay 60x60 - 24"x24"



Clay



Wall: Clay 60x120 - 24"x48" matt  
Roller Clay 10x30 - 4"x12" matt  
Floor: Clay 60x60 - 24"x24" matt

# Ash

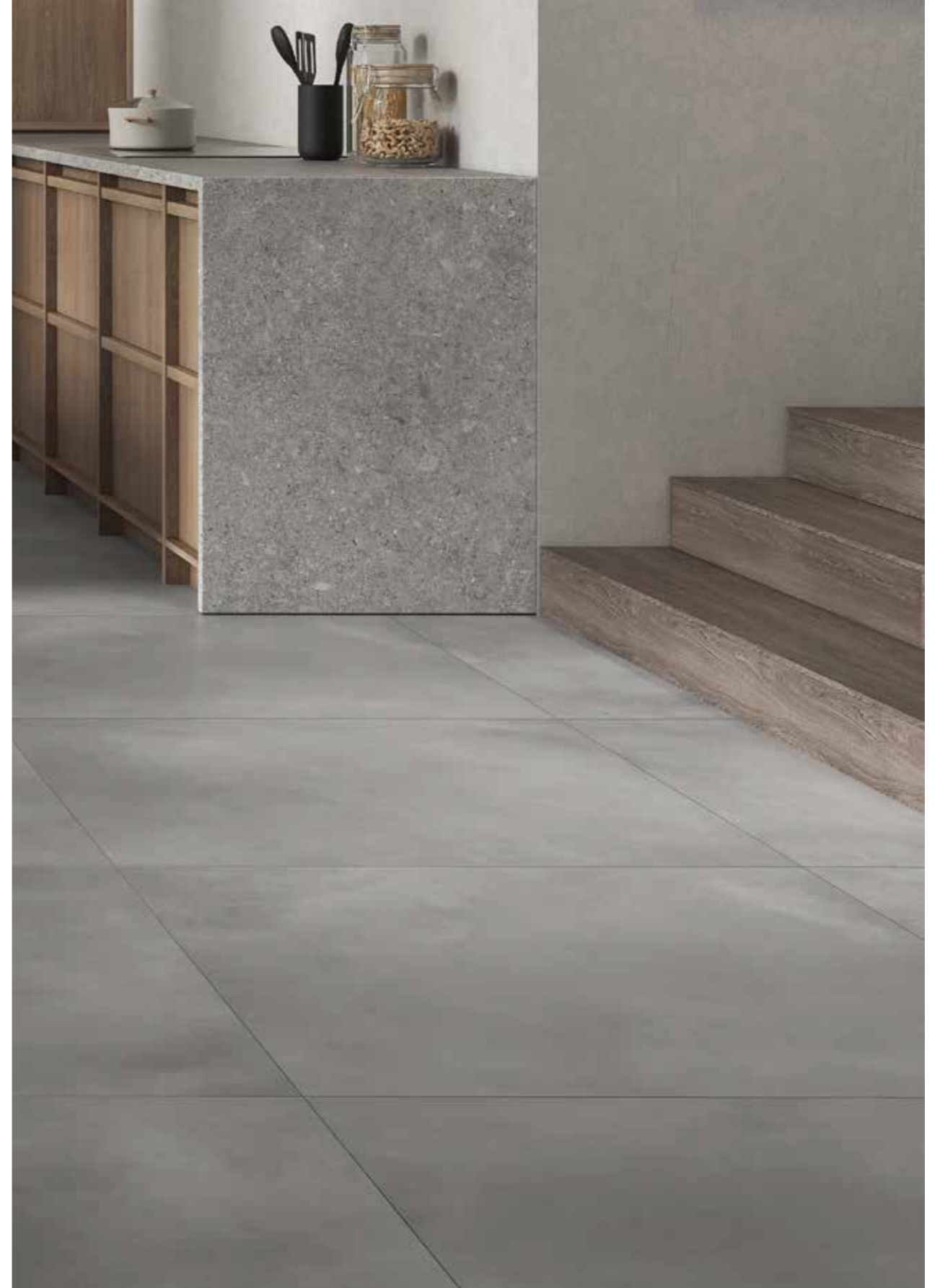

Counter and top: Vicentina Genere  
160x320 - 63"x126" matt  
Floor: Ash 90x90 - 36"x36" matt



Ash

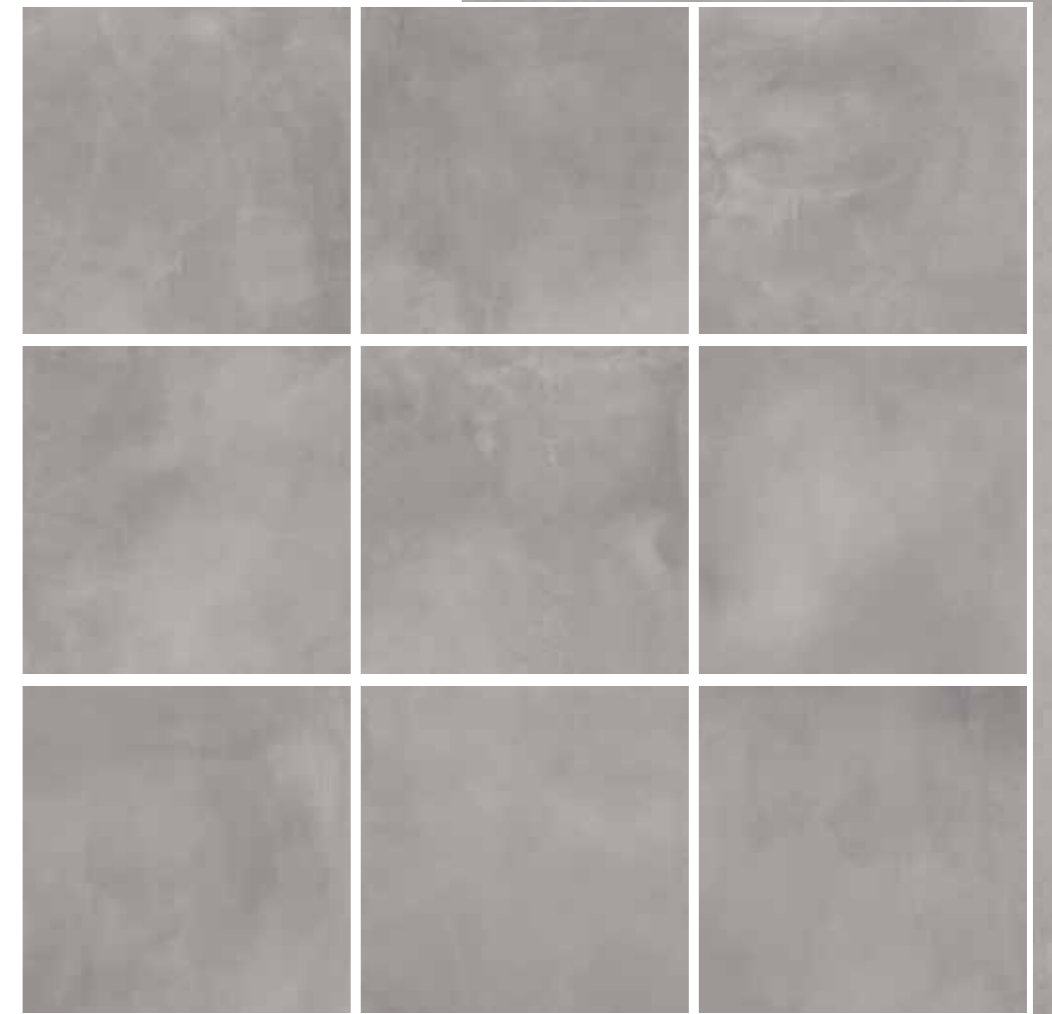

Counter and top: Vicentina Cenere  
160x320 - 63"x126" matt  
Floor: Ash 90x90 - 36"x36" matt

# Mud



Mud 90x90 - 36"x36" matt



Mud

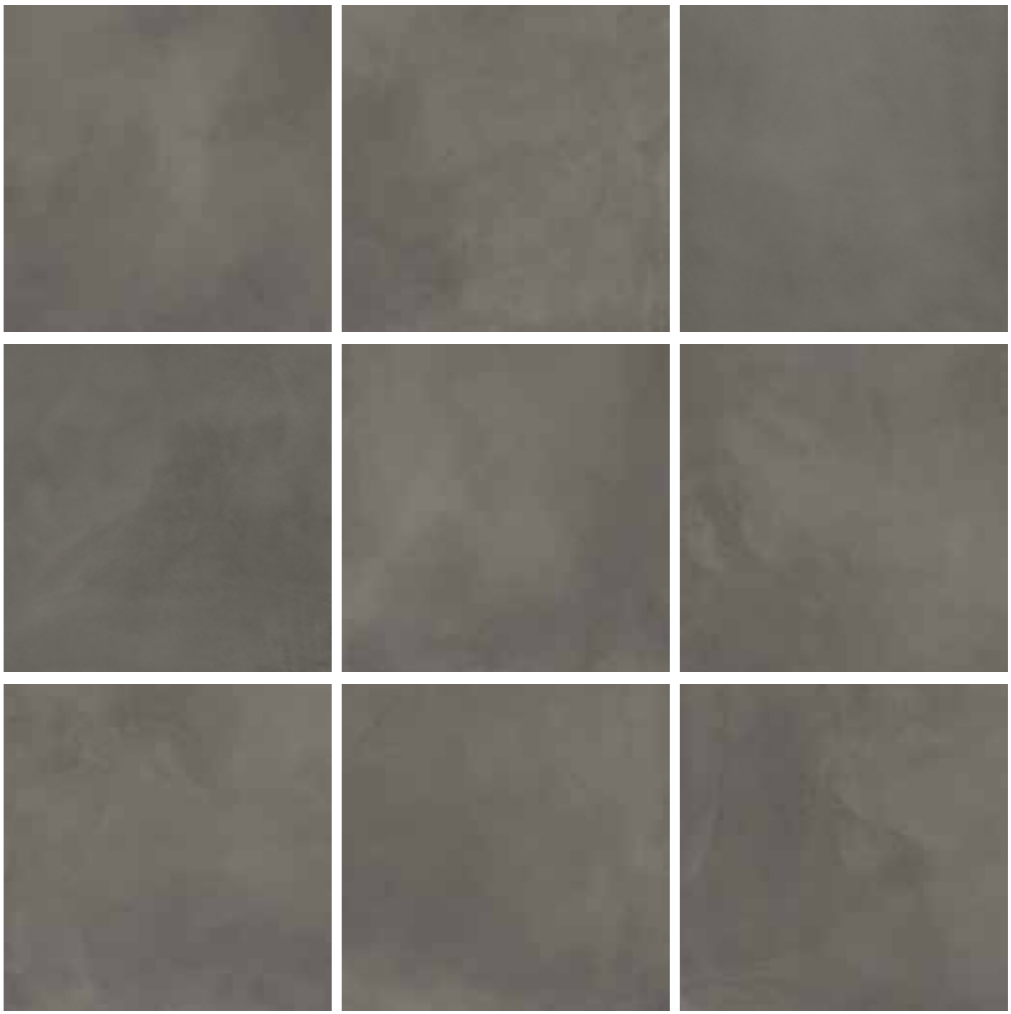

Mud 90x90 - 36"x36" matt

# Crete

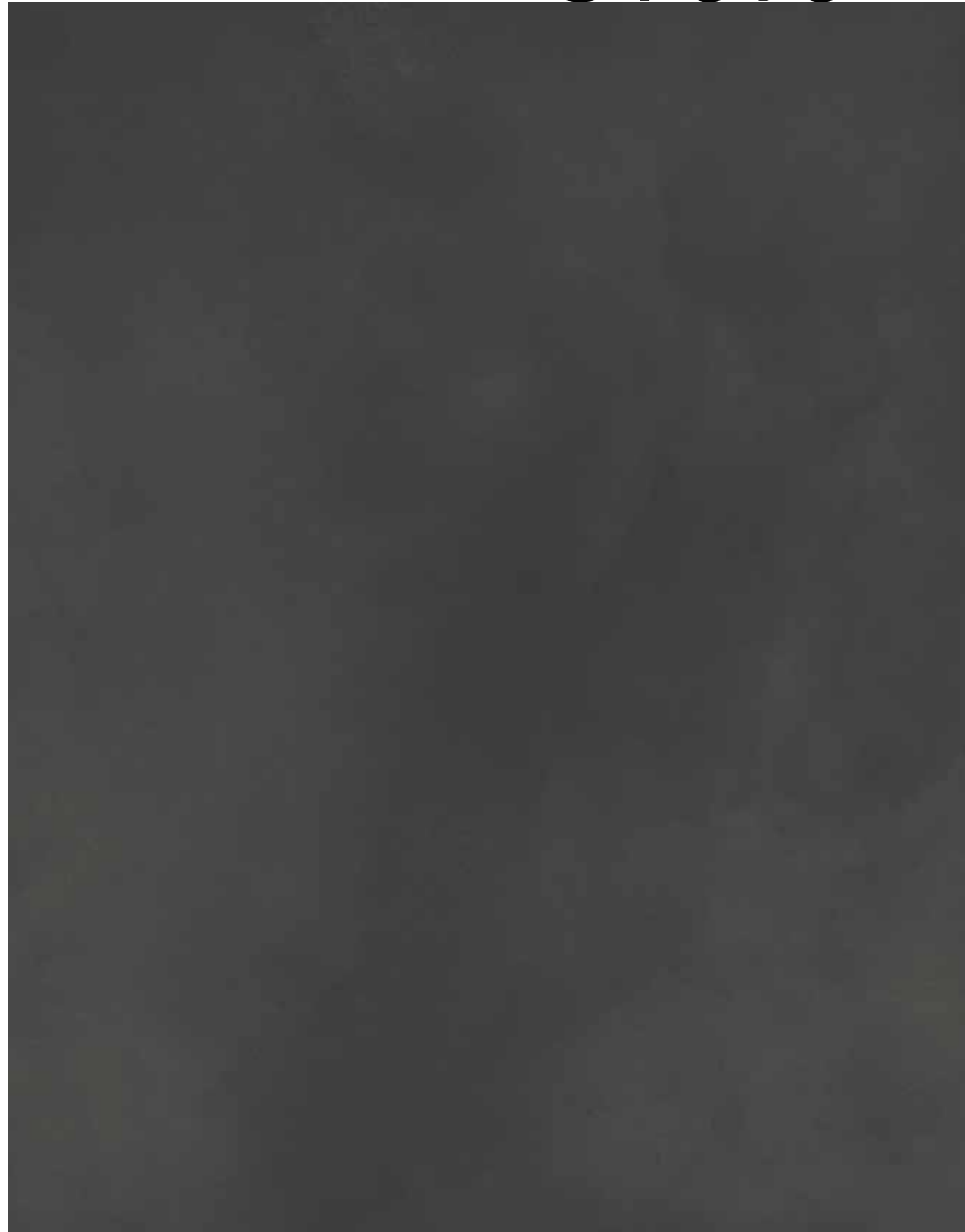

Crete 60x120 - 24"x48" matt



Crete 60x120 - 24"x48" matt

Crete





# Earth

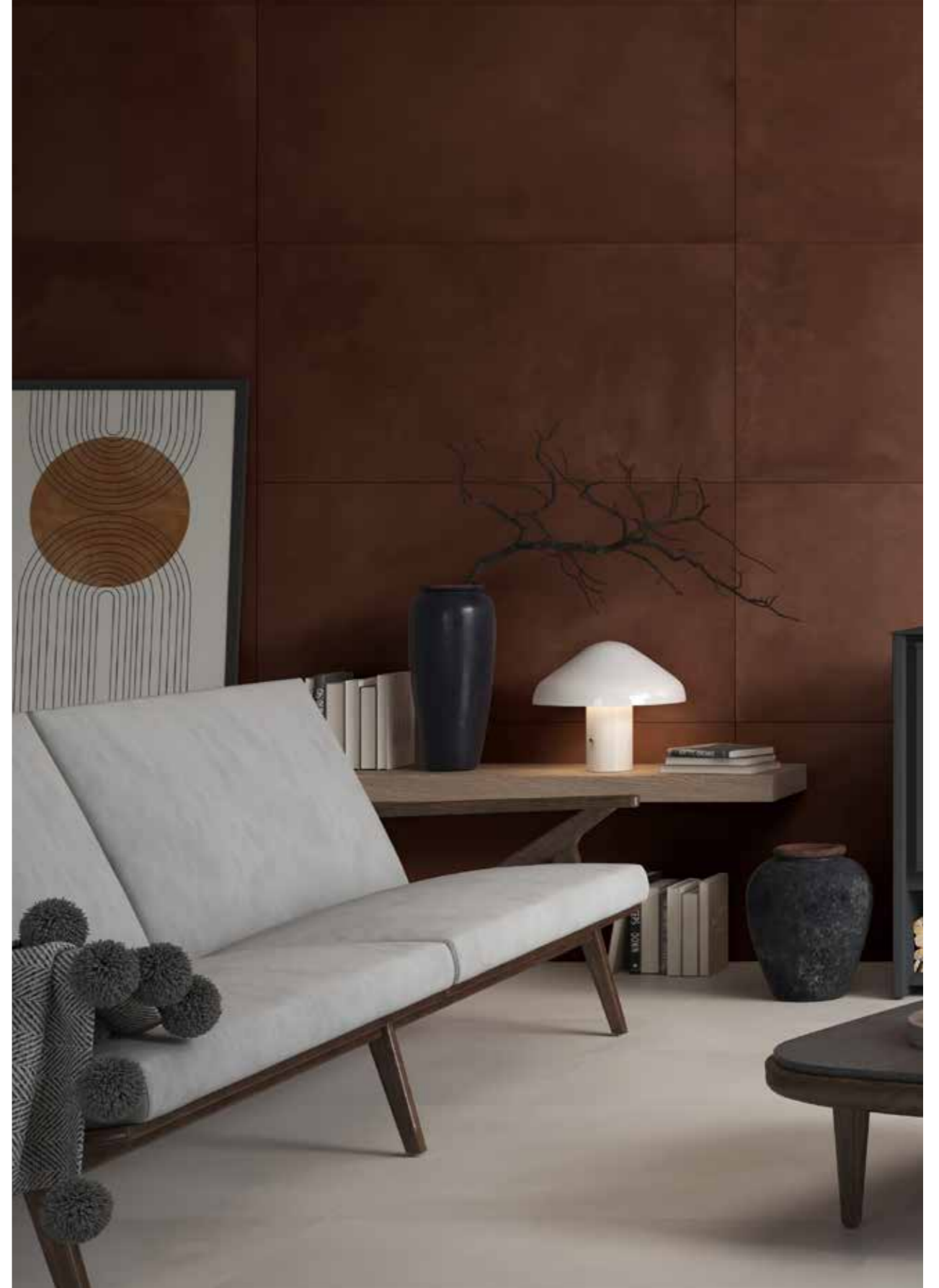

Wall: Earth 60x120 - 24"x48" matt  
Floor: Clay 90x90 - 36"x36" matt



Wall: Earth 60x120 - 24"x48" matt  
Floor: Clay 90x90 - 36"x36" matt

Earth

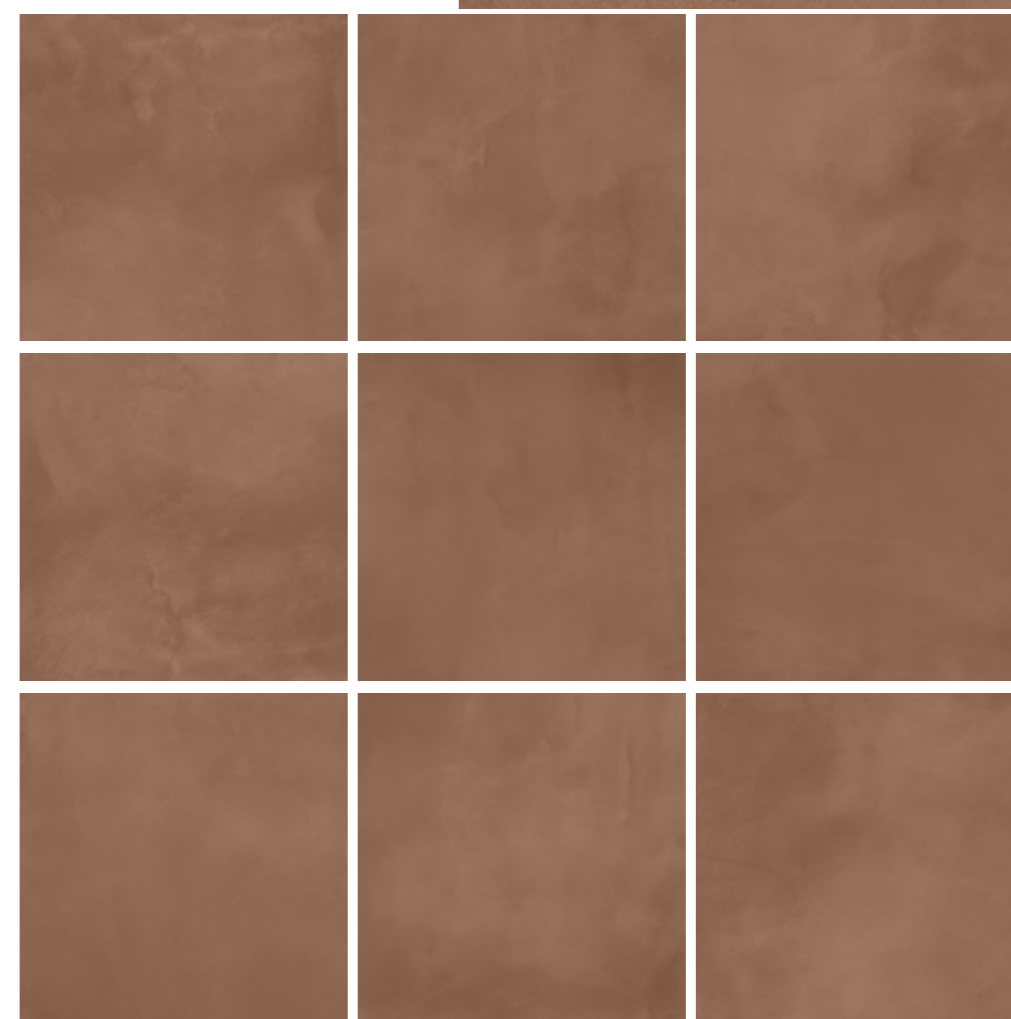

# Decors / Decori hand made

Roller



Roller End



Hyper

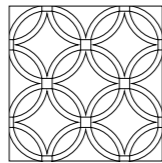

Knit

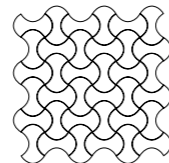

<sup>EN</sup>Norse's decorative program includes a series of elements that combine materials, colours and three-dimensional modular features to provide a sensorial interpretation that amplifies the perception of the wall covering and allows multiple compositions. Designers break away from the conventions of tiles' use, creating evocative and unpredictable spaces by alternating tone-on-tone colours to match the tones of the collection to saturated shades taken from the Hexa palette.

<sup>IT</sup>Il programma decorativo di Norse prevede una serie di complementi che combinando materie, cromatismi e elementi modulari tridimensionali offrono un'interpretazione sensoriale che amplifica la percezione del rivestimento a parete e permette molteplici composizioni. I designer si sottraggono alle solite convenzioni d'uso delle piastrelle, creando spazi suggestivi e imprevedibili, alternando colori tono su tono in pendant con le tonalità della collezione a sfumature sature tratte dalla palette Hexa.



hand  
made

# Hyper

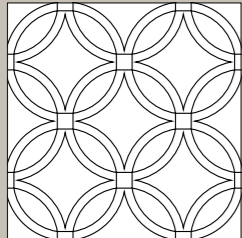

30x30 - 12"x12"  
glossy

Thickness | Spessore  
10mm



White

Wall: Hyper White  
30x30 - 12"x12" glossy  
Floor: Clay 90x90 - 36"x36" matt



# hand made Roller

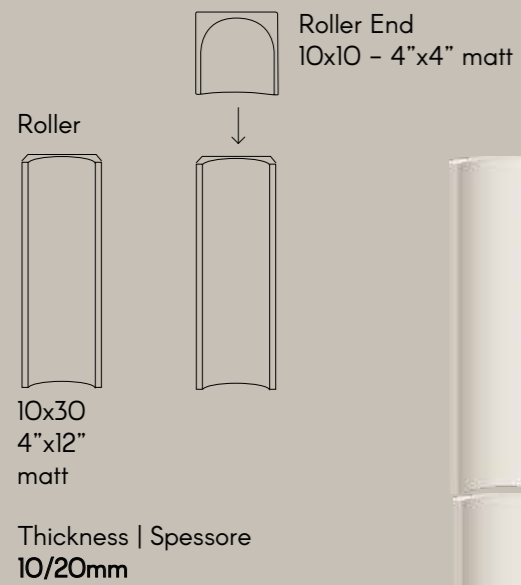

Fog

## Colors

Available in all the colors of the series  
Disponibile in tutti i colori della serie



Clay 60x120 - 24"x48" matt  
Roller Clay 10x30 - 4"x12" matt

hand  
made  
**Knit**

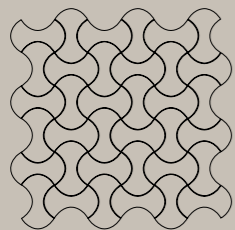

mosaic 30x30  
12"x12" matt

Thickness | Spessore  
10mm

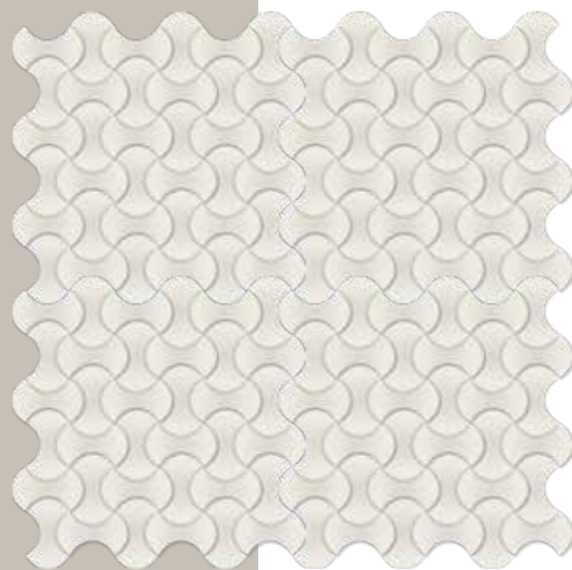

Lemon Sorbet

Colors

Available colors | Colori disponibili



Lemon Sorbet



Wild Sage



Azure Mist

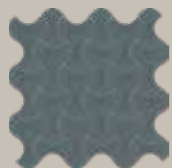

Laurel Green



Rusty Red



Black Swan



Wall: Knit mosaic Lemon Sorbet  
30x30 - 12"x12" matt  
Top: Vicentina Cenere  
160x320 - 63"x126" matt

# Norse Outdoor

## THICK<sub>20mm</sub>

Material: Porcelain stoneware | Gres porcellanato

Surface: ultra matt R11 rectified | ultra matt R11 rettificato

Thickness: 20mm THICK<sub>20mm</sub>

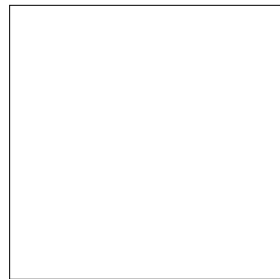

90x90 - 36"x36"  
ultra matt

Powder



Clay



Ash



THICK<sub>20mm</sub>  
COLORS ultra matt



Powder 90x90 - 36"x36"























Ash 90x90 - 36"x36"





Clay 90x90 - 36"x36"

# Packaging Imballi

	BOX			PALLET		
	PZ   PCS	SQ.MT.	KG	BOXES	SQ.MT.	KG
 <b>120x120</b> - 48"x48" matt Fog   Powder   Clay   Ash	2	2,88	59,04	16	46,08	970
 <b>60x120</b> - 24"x48" matt	2	1,44	30,00	32	46,08	980
 <b>90x90</b> - 36"x36" matt	2	1,62	35,00	20	32,40	720
 <b>90x90</b> - 36"x36" ultra matt <b>TH/CK</b> 10mm Powder   Ash   Clay	1	0,81	34,57	21	17,01	746
 <b>60x60</b> - 24"x24" matt	3	1,08	23,75	40	43,20	970
 <b>30x60</b> - 12"x24" matt	6	1,08	23,55	40	43,20	962
 <b>30x30</b> - 12"x12" matt	11	1,00	21,80	48	48,00	1066
 <b>20x60</b> - 8"x24" matt	8	0,96	20,95	48	46,08	1026
 <b>10x60</b> - 4"x24" matt	15	0,90	19,65	40	36,00	806
 <b>10x10</b> - 4"x4" matt	50	0,50	10,90	50	25,00	565
 <b>15x15</b> - 6"x6" matt	44	1,00	21,80	48	48,00	1066
 <b>mosaic 30x30 (5x5)</b> 12"x12" (2"x2") matt	11	1,00	21,50	30	30,00	665
 <b>mosaic 30x60</b> 12"x24" matt	6	1,08	23,25	30	32,40	718
 <b>Hyper 30x30</b> - 12"x12" glossy	5	0,50	10,90	50	25,00	565
 <b>Roller 10x30</b> 4"x12" matt	16	0,48	10,00	42	20,16	440
 <b>Roller End 10x10</b> 4"x4" matt	13	0,13	2,68	115	14,95	330
 <b>Knit 30x30</b> 12"x12" matt	7	0,63	9,00	42	26,46	398
 <b>skirting 5x60</b> - 2"x24" matt	12	7,20ml	8,00	-	-	-
 <b>skirting 5x90</b> - 2"x36" matt	12	10,80ml	12,00	-	-	-
 <b>step 30x60</b> - 12"x24" matt	6	-	26	-	-	-
 <b>step tread 34x90</b> 14"x36" matt	2	-	17,50	-	-	-

The information contained in this catalogue is correct to the best of our knowledge and update at the catalogue printing time; therefore the listed data is subject to change. The colours and shades shown here are only indicative.

Le informazioni contenute nel presente catalogo sono il più possibile esatte ed aggiornate al momento della stampa, pertanto i dati elencati possono subire variazioni. I colori e le tonalità qui riprodotti sono indicativi.

# Technical Features

## Caratteristiche tecniche

valid for **NORSE matt** | ultra matt



TECHNICAL FEATURES UNGLAZED PORCELAIN STONEWARE  
CONFORMING TO EUROPEAN STANDARDS EN 14411 ISO 13006 APP. G (GROUP BIA UGL WITH  $E_b \leq 0,5\%$ )

CARATTERISTICHE TECNICHE GRÈS PORCELLANATO NON SMALTATO Conformi a Norme Europee EN 14411 ISO 13006 App. G (Gruppo Bia UGL con  $E_b \leq 0,5\%$ )  
TECHNISCHE EIGENSCHAFTEN UNGLASIERTES FEINSTEINZEUG Gemäß den Europäischen Normen EN 14411 ISO 13006 App. G (Gruppe Bia UGL mit  $E_b \leq 0,5\%$ )  
CARACTERISTIQUES TECHNIQUES GRES CERAME NON ÉMAILLÉ Conformes aux Normes Européennes EN 14411 ISO 13006 App. G (Groupe Bia UGL avec  $E_b \leq 0,5\%$ )

	TECHNICAL FEATURES CARATTERISTICHE TECNICHE TECHNISCHE DATEN CARACTERISTIQUE TECHNIQUE	TESTING METHOD METODICA DI PROVA PRÜFVERFAHREN NORME D'ESSAIS	REFERENCE STANDARD RIFERIMENTO NORMA STANDARDWERT RÉFÉRENCE NORME	TEST RESULTS VALORE PRODOTTO PRODUKT WERTE VALEUR PRODUIT	
	Sizes Dimensioni Abmessungen Dimensions	EN ISO 10545-2	N ≥ 15 cm • Length and width - Lunghezza e larghezza Länge und Breite - Longueur et largeur • Thickness - Spessore - Stärke - Epaisseur • Linearity - Rettilineità spigoli - Kantengeradheit- Rectitude des arêtes • Wedging - Ortogonalità - Rechtwinkligkeit Orthogonalité • Warpage - Planarità - Ebenföchigkeit-Planéité • Appearance: percentage of acceptable tiles, per lot Aspetto: percentuale di piastrelle accettabili nel lotto Eigenschaften entsprechen/Aspect: pourcentage de carreaux acceptables sur la fourniture totale	(%) (mm) ±0,6% ±2,0 mm ±5,0 ±0,5 0,5 ±1,5 ±0,5 ±2,0 0,5 ±2,0 95% min.	Compliant Conforme Erfüllt Conforme
	Water absorption Assorbimento acqua Wasseraufnahme Absorption d'eau	EN ISO 10545-3	$E_b \leq 0,5\%$		Compliant Conforme Erfüllt Conforme
	Modulus of rupture Resistenza alla flessione Biegezugfestigkeit Résistance à la flexion	EN ISO 10545-4	Medium value 35 N/mm <sup>2</sup> min.		Compliant Conforme Erfüllt Conforme
	Breaking strength Carico di rottura Bruchlast Charge de rupture		sp. > = 7,5 mm: min 1300 N		Compliant Conforme Erfüllt Conforme
	Abrasion resistance Resistenza all'abrasione Abriebbeständigkeit Résistance à l'abrasion	EN ISO 10545-6	175 mm <sup>3</sup> max		Average Medio - Mittelwert Moyenne < 150 mm <sup>3</sup>
	Thermal expansion coefficient Coefficiente di dilatazione termica lineare Wärmeausdehnungskoeffizient Coefficient de dilatation thermique linéaire	EN ISO 10545-8	*Declared value Valore dichiarato Angegebener Wert Valeur déclaré		≤9 MK-1
	Thermal shock resistance Resistenza agli sbalzi termici Temperaturwechselbeständigkeit Résistance aux écarts de température	EN ISO 10545-9	*Pass according to ISO 10545-1 Test superato in accordo con ISO 10545-1 Test überstanden nach ISO 10545-1 Pv en accord avec norme en 10545-1		Resistant Resistente Widerstandsfähig Résistant
	Frost resistance Resistenza al gelo Frostbeständigkeit Résistance au gel	EN ISO 10545-12	*Pass according to ISO 10545-1 Test superato in accordo con ISO 10545-1 Test überstanden nach ISO 10545-1 Pv en accord avec norme en 10545-1		Resistant Resistente Widerstandsfähig Résistant
	Resistance to low concentrations of acids and alkali Resistenza a basse concentrazioni di acidi e alcali Beständigkeit gegen schwach konzentrierten Säuren und Laugen Résistance à des basses concentrations d'acides et bases		*Declared value Valore dichiarato Angegebener Wert Valeur déclaré		From ULA to ULB Da ULA a ULB Von ULA bis ULB De ULA jusqu'à ULB
	Resistance to high concentrations of acids and alkali Resistenza ad alte concentrazioni di acidi e alcali Beständigkeit gegen stark konzentrierten Säuren und Laugen Résistance à des hautes concentrations d'acides et bases	EN ISO 10545-13	*Declared value Valore dichiarato Angegebener Wert Valeur déclaré		From UHA to UHB Da UHA a UHB Von UHA bis UHB De UHA jusqu'à UHB
	Resistance to domestic chemicals and additives for swimming pools Resistenza ai prodotti chimici di uso domestico e agli additivi per piscina Beständigkeit gegen chemischen Haushaltsreinige und Zusatzstoffe für Schwimmbäder Résistance aux prod. chimiques d'usage domestique et additifs pour piscines				UB min. UA
	Stain resistance Resistenza alle macchie Fleckenbeständigkeit Résistance aux taches	EN ISO 10545-14	*Declared value Valore dichiarato Angegebener Wert Valeur déclaré		CLASS 5
	Colors resistance to light Resistenza dei colori alla luce Lichtbeständigkeit Résistance des couleurs a la lumière	DIN 51094	No noticeable color change. Non devono presentare apprezzabili variazioni di colore. Die Muster dürfen keine sichtbaren Farbveränderungen aufweisen. Ne doivent pas présenter de variations importantes des couleurs.		No alteration after testing Materiale inalterato dopo il test Keine Veränderung nach dem Test Aucune altération relevée
	Friction coefficient (Slipperiness) Coefficiente di attrito (Scivolosità) Reibungskoeffizient (Schlupfbarkeit) Coefficient de friction (Glissement)	DIN 51130 ANSI A137.1 (DCOF)	*Declared value Valore dichiarato Angegebener Wert Valeur déclaré		R10 matt R11 ultra matt >0,42

TERRATINTA  
group



"Stay hungry, stay foolish."

S. Jobs 1955-2011

---



CHANGE  
TOGETHER

*#notaclassicstory*

brand of **Terratinta Group Srl SB**

// 45, via Viazza II Tronco  
41042 Fiorano Modenese (MO) Italy

T +39 0536911408

F +39 05361940223

 Terratinta Group

 terratintagroup

*#terratintastyle*



**terratinta**  
ceramiche   
[terratintagroup.com](http://terratintagroup.com)